

Maße (mm)  
Dimensions (mm)  
Dimensiones (mm)

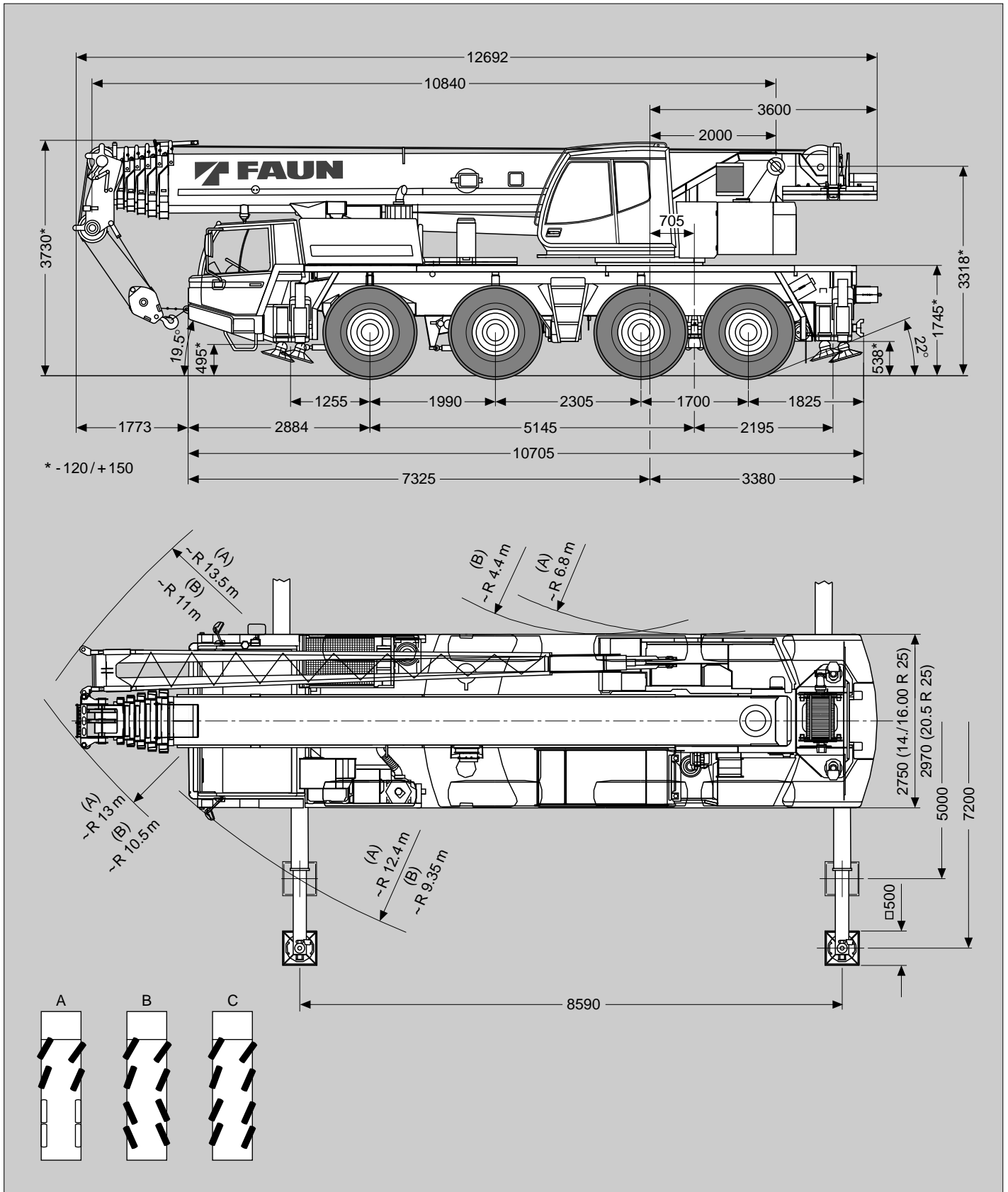

Hubhöhen  
Lifting heights  
Hauteurs de levage  
Alturas de elevación

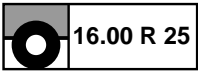
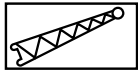
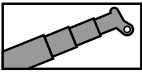

18t

DIN/ISO

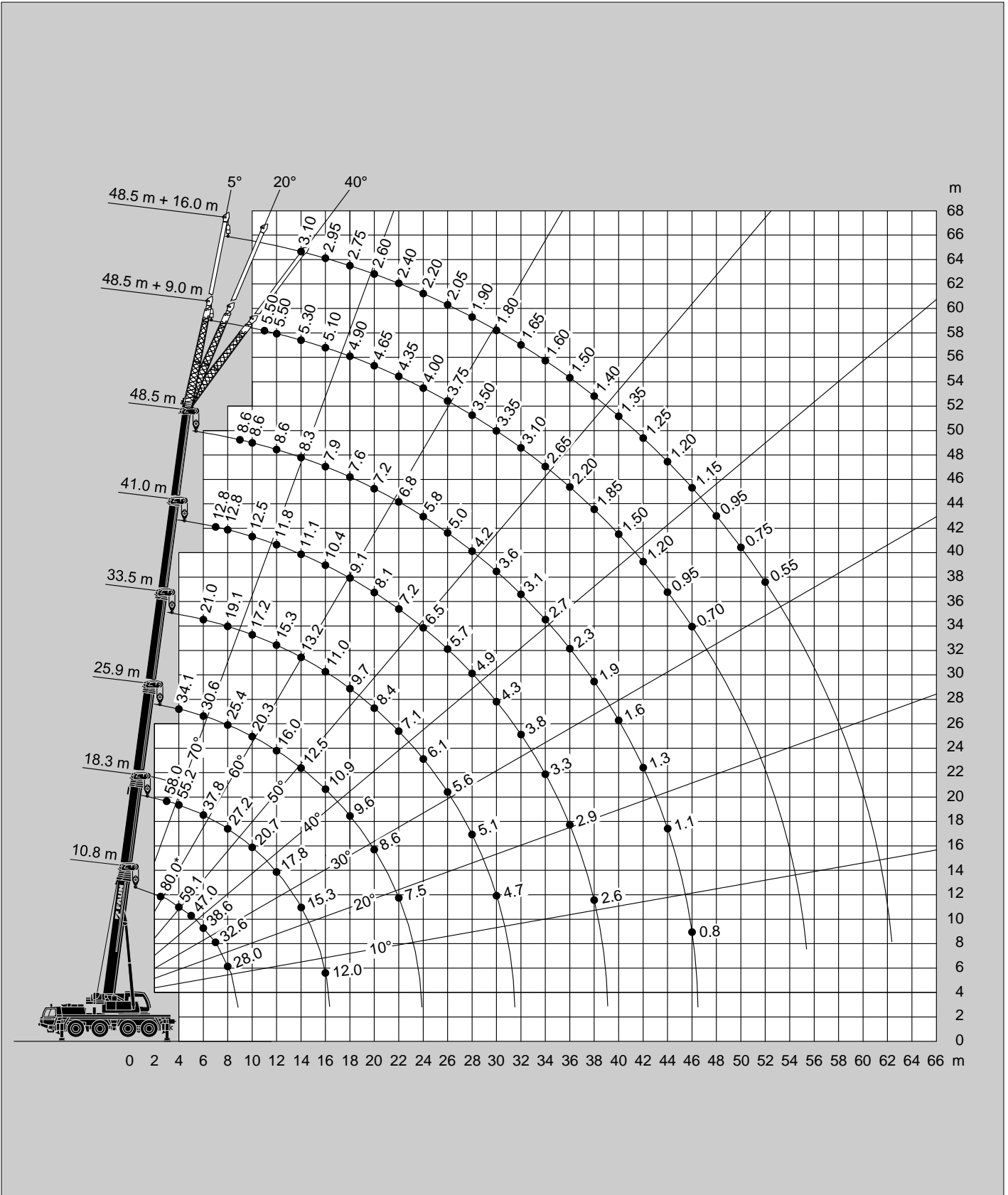

Tragfähigkeiten  
Lifting capacities  
Capacités de levage  
Capacidades de elevación

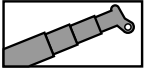

18t

DIN/ISO

m	10.8 m	14.6 m	18.3 m	22.1 m	25.9 m	29.7 m	33.5 m	37.3 m	41.0 m	44.8 m	48.5 m
2.5	80.0*										
3.0	73.0	68.0	58.0	47.0							
3.5	66.8	63.6	58.0	45.0							
4.0	59.1	59.0	55.2	42.9	34.1						
4.5	52.6	52.5	51.0	40.9	33.2						
5.0	47.0	47.0	46.1	38.9	32.4	27.0					
6.0	38.6	38.6	37.8	34.8	30.6	25.4	21.0				
7.0	32.6	32.6	31.8	30.7	28.0	23.9	20.0	16.0	12.8		
8.0	28.0	28.0	27.2	26.6	25.4	22.3	19.1	15.4	12.8	10.0	
9.0		24.4	23.6	23.1	22.8	20.8	18.1	14.8	12.8	10.0	8.6
10.0		21.5	20.7	20.2	20.3	19.2	17.2	14.2	12.5	10.0	8.6
11.0		19.1	19.3	17.9	17.9	17.7	16.2	13.6	12.1	9.8	8.6
12.0		17.3	17.8	15.9	16.0	16.1	15.3	13.0	11.8	9.6	8.6
14.0			15.3	12.4	12.5	12.9	13.2	11.8	11.1	9.1	8.3
16.0			12.0	9.6	10.9	10.2	11.0	10.6	10.4	8.7	7.9
18.0				8.6	9.6	8.9	9.7	9.5	9.1	8.2	7.6
20.0				6.9	8.6	8.0	8.4	8.5	8.1	8.0	7.2
22.0					7.5	7.2	7.1	7.7	7.2	7.2	6.8
24.0						6.5	6.1	6.7	6.5	6.1	5.8
26.0						5.8	5.6	5.8	5.7	5.3	5.0
28.0							5.1	5.1	4.9	4.6	4.2
30.0							4.7	4.5	4.3	3.9	3.6
32.0								4.0	3.8	3.4	3.1
34.0								3.5	3.3	3.0	2.7
36.0									2.9	2.6	2.3
38.0									2.6	2.2	1.9
40.0										1.9	1.6
42.0										1.6	1.3
44.0											1.1
46.0											0.8

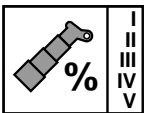

I  
II  
III  
IV  
V

0	0/0	50/0/100/0	100/0/0	100/0/0	100/0/0	100/0/0	100/100/0/0	100/0/0	100/100/0	100/50	100
0	50/0	50/0/0/0	50/0/0	100/0/0	100/0/0	100/0/0	100/100/100/0	100/100/50	100/100/100	100/100	100
0	0/0	0/0/0/0	0/0/0	0/100/0	50/100/50	50/100/50	50/100/100/100	100/100/100	100/100/100	100/100	100
0	0/0	0/50/0/0	0/100/50	0/50/100	0/50/100	0/100/100	50/0/50/100	50/100/100	50/100/100	100/100	100
0	0/50	0/50/0/100	0/50/100	0/50/100	0/50/100	0/50/100	0/0/50/100	0/50/100	50/0/100	50/100	100

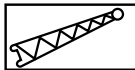
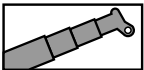

18t

DIN/ISO

m	44.8 m + 9.0 m			48.5 m + 9.0 m			48.5 m + 16.0 m		
	5°	20°	40°	5°	20°	40°	5°	20°	40°
10.0	6.00								
11.0	5.85			5.50					
12.0	5.70	3.85		5.50					
14.0	5.35	3.60	2.45	5.30	3.70		3.10		
16.0	5.05	3.40	2.35	5.10	3.50	2.40	2.95		
18.0	4.75	3.20	2.30	4.90	3.30	2.35	2.75	1.70	
20.0	4.40	3.05	2.20	4.65	3.15	2.25	2.60	1.60	
22.0	4.10	2.90	2.15	4.35	3.00	2.20	2.40	1.55	1.00
24.0	3.80	2.75	2.10	4.00	2.85	2.15	2.20	1.45	1.00
26.0	3.55	2.65	2.05	3.75	2.75	2.10	2.05	1.40	0.95
28.0	3.30	2.50	2.00	3.50	2.60	2.05	1.90	1.30	0.95
30.0	3.15	2.45	1.95	3.35	2.55	2.00	1.80	1.25	0.90
32.0	2.95	2.35	1.95	3.10	2.45	1.95	1.65	1.20	0.90
34.0	2.80	2.25	1.90	2.65	2.35	1.95	1.60	1.15	0.85
36.0	2.50	2.20	1.85	2.20	2.25	1.90	1.50	1.10	0.85
38.0	2.15	2.10	1.85	1.85	2.00	1.90	1.40	1.05	0.85
40.0	1.80	1.90	1.85	1.50	1.65	1.75	1.35	1.00	0.80
42.0	1.50	1.60	1.65	1.20	1.30	1.40	1.25	1.00	0.80
44.0	1.25	1.30	1.30	0.95	1.05	1.10	1.20	0.95	0.80
46.0	1.00	1.05	1.05	0.70	0.80	0.80	1.15	0.90	0.75
48.0	0.75	0.80	0.75		0.55	0.55	0.95	0.85	0.75
50.0	0.55	0.55					0.75	0.80	0.75
52.0							0.55	0.60	0.70

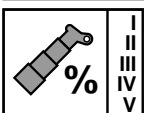

I  
II  
III  
IV  
V

100 / 50				100				100		
100 / 100				100				100		
100 / 100				100				100		
100 / 100				100				100		
50 / 100				100				100		